

## **Electrocardiograms Made Easy! Part III. Interpreting Ventricular Dysrhythmias**

### **NYSNA Continuing Education**

The New York State Nurses Association is accredited as a provider of continuing nursing education by the American Nurses Credentialing Center's Commission on Accreditation.

This course has been awarded 1.5 contact hours.

All American Nurses Credentialing Center (ANCC) accredited organizations' contact hours are recognized by all other ANCC accredited organizations. Most states with mandatory continuing education requirements recognize the ANCC accreditation/approval system. Questions about the acceptance of ANCC contact hours to meet mandatory regulations should be directed to the Professional licensing board within that state.

NYSNA has been granted provider status by the Florida State Board of Nursing as a provider of continuing education in nursing (Provider number 50-1437).

## **How to Take This Course**

Please take a look at the steps below; these will help you to progress through the course material, complete the course examination and receive your certificate of completion.

### **1. REVIEW THE OBJECTIVES**

The objectives provide an overview of the entire course and identify what information will be focused on. Objectives are stated in terms of what you, the learner, will know or be able to do upon successful completion of the course. They let you know what you should expect to learn by taking a particular course and can help focus your study.

### **2. STUDY EACH SECTION IN ORDER**

Keep your learning "programmed" by reviewing the materials in order. This will help you understand the sections that follow.

### **3. COMPLETE THE COURSE EXAM**

After studying the course, click on the "Course Exam" option located on the course navigation toolbar. Answer each question by clicking on the button corresponding to the correct answer. All questions must be answered before the test can be graded; there is only one correct answer per question. You may refer back to the course material by minimizing the course exam window.

### **4. GRADE THE TEST**

Next, click on "Submit Test." You will know immediately whether you passed or failed. If you do not successfully complete the exam on the first attempt, you may take the exam again. If you do not pass the exam on your second attempt, you will need to purchase the course again.

### **5. FILL OUT THE EVALUATION FORM**

Upon passing the course exam you will be prompted to complete a course evaluation. You will have access to the certificate of completion **after you complete the evaluation**. At this point, you should print the certificate and keep it for your records.

## Introduction

**Electrocardiograms Made Easy! is a series of three courses comprised of: Basic EKG Interpretations, Interpreting Abnormal Atrial Rhythms, and Interpreting Ventricular Dysrhythmias.**

This final course of the series will discuss ventricular dysrhythmias, many of which need immediate intervention or are not supportive of life. It builds from the previous concepts learned from Basic EKG Interpretations and Interpreting Abnormal Atrial Rhythms. In learning about ventricular dysrhythmias, we will advance the concepts related to electrical physiology and the electrocardiogram, focusing on different rhythm presentations, and the mechanical and electrical process involved. To achieve this, the pathophysiology behind differing dysrhythmias will be presented, allowing conceptualization of the mechanical/electrical processes occurring in the dysfunctional cardiac cycle. This assumes that the learner is competent in the basic electrocardiogram principles. If needed please refer to the first two courses in this series.

Cardiovascular disease is composed of heart disease and cerebrovascular accidents (strokes). Respectively they are the leading and third leading cause of death in the United States. Together they account for the death of more than 1.3 million Americans each year (Centers for Disease Control and Prevention [CDC], n.d.). More broadly, 80 million Americans (almost one third of the population) suffer from some form of cardiovascular disease (CDC, n.d.). With tightening purse strings, the impact of cardiovascular diseases on healthcare resources is astounding. The Center for Disease Control and Prevention (CDC) estimates that in 2008 the cost of cardiovascular disease to the economy was over \$448 billion (CDC, n.d.). So what does this mean to me?

As active participants in healthcare you will undoubtedly come in contact with the 1 in 4 Americans who have cardiovascular disease. This contact may be in any setting, from an emergency department, surgical ward, rehabilitation or your own family home. So it is important to be familiar with and understand the basics of one of the easiest, most cost-effective, non-invasive tests performed to assess cardiac function: the electrocardiogram. It is important to be able to interpret electrocardiograms in order for the skilled Registered Nurse to initiate timely interventions.

## Content Outline

- Ventricular dysrhythmia etiology
- Ventricular dysrhythmias
  1. Premature ventricular contraction (PVC)
  2. Idioventricular rhythm
  3. Accelerated idioventricular rhythm
  4. Ventricular tachycardia
  5. Ventricular fibrillation
  6. Asystole
- Pacemaker rhythms
- Atrioventricular blocks (AV blocks)
  1. First-degree block
  2. Second-degree block type I
  3. Second-degree block type II
  4. Third-degree block (complete heart block)

## **Course Objectives**

1. Identify dysrhythmias not supportive to life
2. Identify which rhythm indicates a block and requires immediate intervention
3. Explain why a P wave may not be visible

## **About the Author**

**David Pickham, MN, RN**, began his nursing education at the University of Newcastle in New South Wales, Australia. He has since worked as a registered nurse focusing on emergency medicine in Australia, Canada, and the United States. He has a master's of nursing in advanced practice and currently is a doctoral candidate at the University of California. His interests lie specifically in the field of electrocardiography (also known as ECG or EKG) which led him to create courses on Electrocardiograms Made Easy!

This course was updated in August 2008 by **Sally Dreslin, MA, RN, CEN**. Ms Dreslin is an Associate Director in the Education, Practice and Research Program of the New York State Nurses Association.

## Ventricular Dysrhythmia Etiology

Unlike atrial dysrhythmias, ventricular dysrhythmias originate below the level of the atria within the Purkinje fibers (see Figure 1). Work through this with me if you will. If the impulse doesn't originate in the atria, then we cannot expect to see a P wave. Remember the P wave represents atrial contraction and should be followed by a QRS complex in a normal cardiac rhythm.

Figure 1. "Conduction System Pathway" Courtesy of: University of Otago

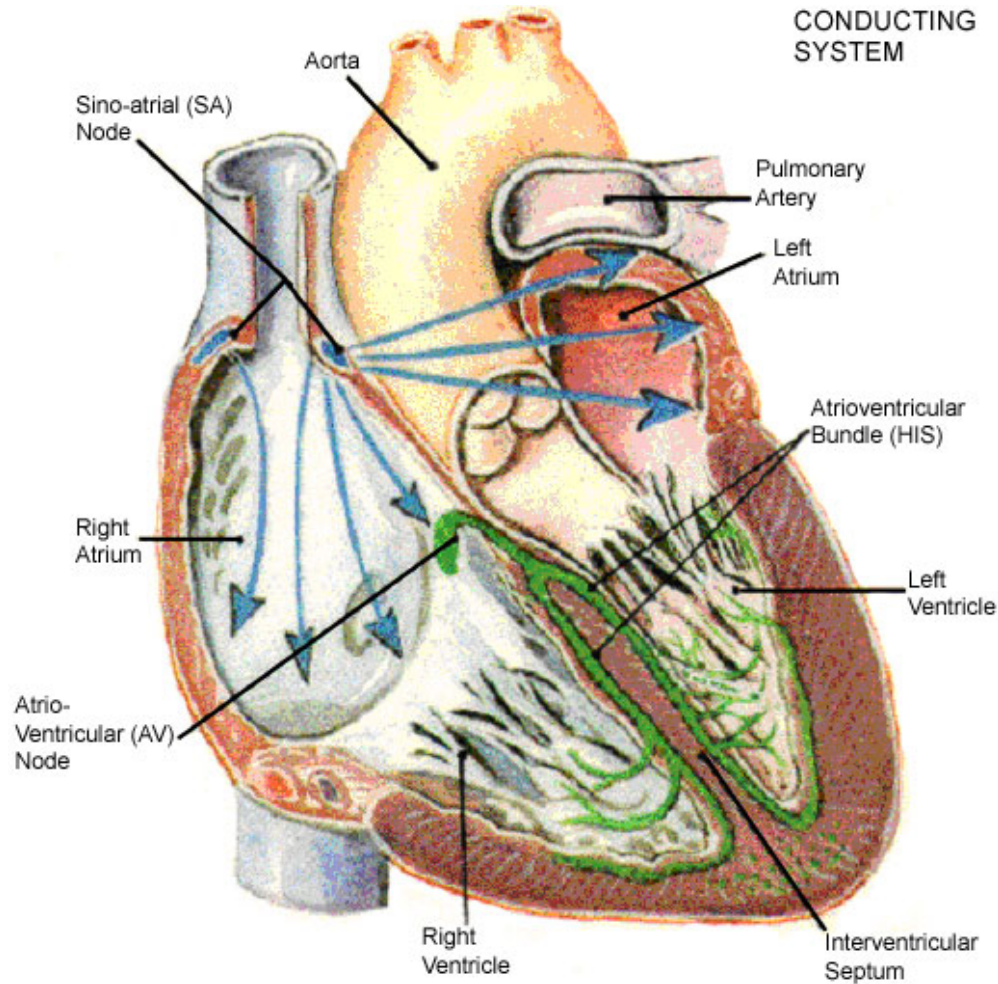

In a ventricular dysrhythmia, the impulse originates somewhere in the Purkinje fibers, spreading across the left and right ventricle wall before conducting through to the atria. This will result in a wide QRS complex (due to the time it takes the impulse to conduct through the non-specific pathways in the ventricles).

If we think of the wave morphology, the impulse generated in the QRS complex will result in the P wave being absent or cause the P wave to be flipped upside down. This flipping is a result of the impulse traveling in the opposite direction, than a normal conducted stimulus. As the stimulus is traveling in the opposite direction the P wave is represented on an EKG as a negative wave (flipped).

Do you remember the intrinsic rate of the Purkinje fibers? If so you will be able to estimate what the expected rate of a ventricular rhythm will be (see Figure 2).

Figure 2.

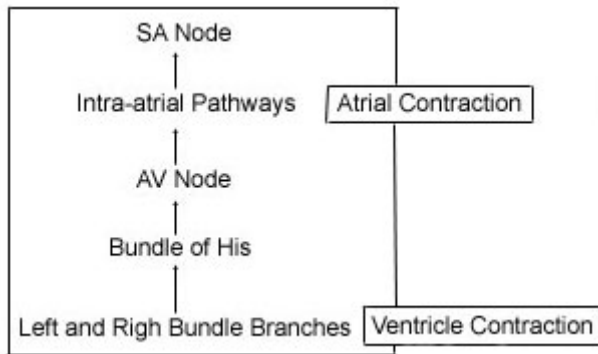

## Ventricular Dysrhythmias

### Premature Ventricular Contraction (PVC)

Like all rhythms we have interpreted so far the rhythm name describes the processes occurring. This rhythm is no different. PVC simply means that there is an early contraction of the ventricles. This is illustrated in Figure 3.

Figure 3. *Premature Ventricular Contractions*

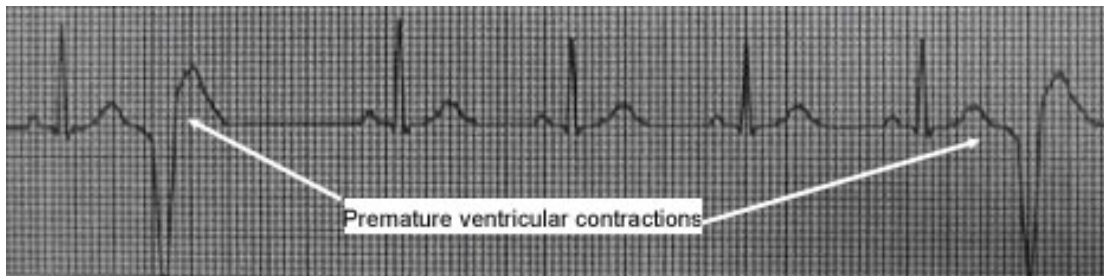

Look at Figure 3, now this isn't really a dysrhythmia like other rhythms we have seen. This is a normal rhythm with episodes of electrical conduction malfunction. Let's work through the questions (ignore the PVCs while doing these).

What is the rate? **60-75 bpm**

Is the rhythm regular or irregular? **Regular**

Is there a P wave present? **Yes**

Is the PR interval fixed or varied? **Fixed**

Is the QRS wide or narrow? **Narrow**

Do you think that this is normal sinus rhythm? Great job. So we know we have normal sinus rhythm. Now let's describe what is occurring. Look at these abnormal QRS complexes. Are they narrow or wide? Good, so you can see they are wide. We know that a narrow QRS complex means that the impulse originated in the atria. A wide QRS complex must therefore represent an impulse that generated in the ventricles. Because the QRS complexes originate out of sync with normal cardiac function we say that we have normal sinus rhythm with premature ventricular contractions.

Great! Now let's advance this concept. In Figure 3 you can see that the PVCs look similar in their directions (both pointing down). We state that they are unifocal PVCs. This simply means that there is one point of impulse origin. But what happens when they point in different directions? See Figure 4.

Figure 4. *Multifocal PVCs*

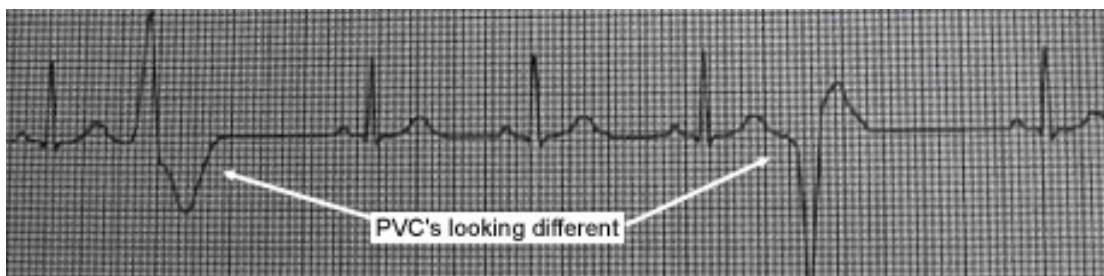



As you can see in Figure 4, we have two wide QRS complexes with an underlying normal sinus rhythm. As they are represented as one upward and one downward, we can figure out that the stimulus must be from more than one. Knowing this, we can then label Figure 4 as normal sinus rhythm with multifocal PVCs (having more than one point of impulse origin).

Okay, so we know what a premature ventricular contraction is and now we can distinguish whether they are unifocal or multifocal in origin. Now we need to describe their rate of occurrence. We have four common types.

If the PVC occurs every other beat, as in Figure 5, we label this Bigeminy.

Figure 5. *Bigeminy*



If it occurs every third beat, as in Figure 6, we label this Trigeminy.

Figure 6. *Trigeminy*

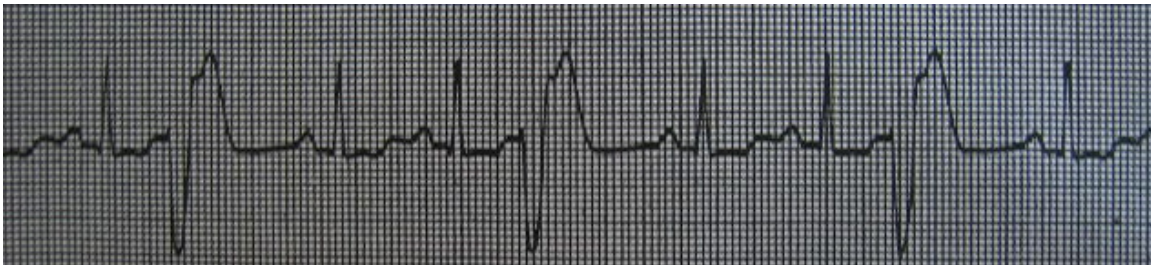

If we have two PVCs in a row, as in Figure 7, we label this a Couplet.

Figure 7. *Couplet's*

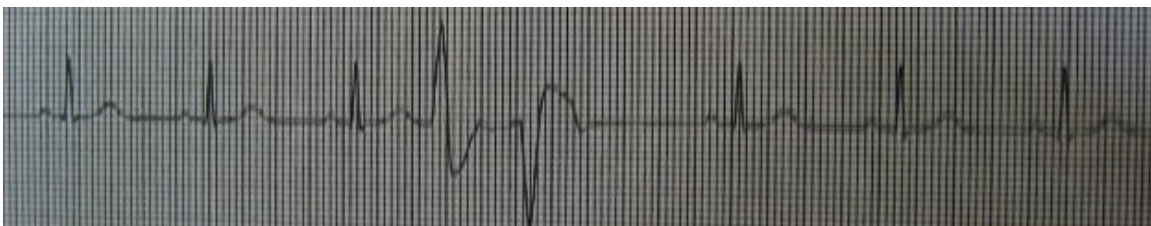

Lastly, if we have 3 PVCs in a row, as in Figure 8, we label this a Triplet.

Figure 8. *Triplet's*

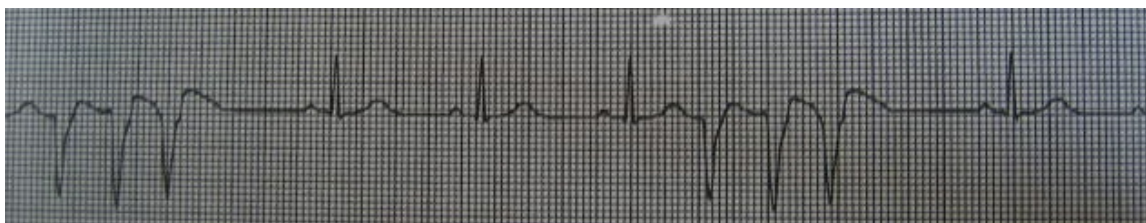

Seems pretty straight forward, right? Well let's move on to another rhythm.

### Idioventricular Rhythm

We have seen plenty of rhythms where the pacemaker is situated in the SA node or AV node. This will be the first rhythm where the heart's pacemaker is originating within the ventricles. See Figure 9.

Figure 9. *Courtesy of: Newberry (2003)*

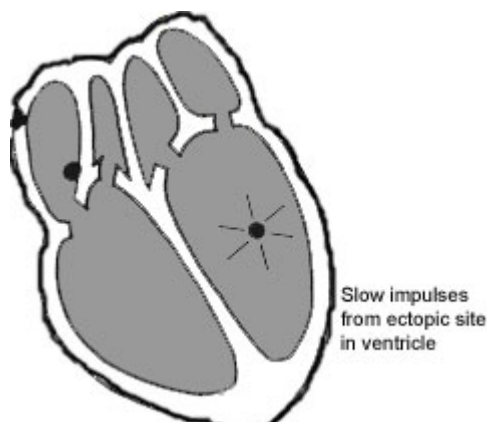

Note how there is one stimulus area in the ventricles acting as the heart's primary pacemaker. Start thinking about what this will do to the rhythm strip. What is the ventricle's intrinsic rate? Review Figure 10 and answer the five questions.

Figure 10. *Idioventricular rhythm*

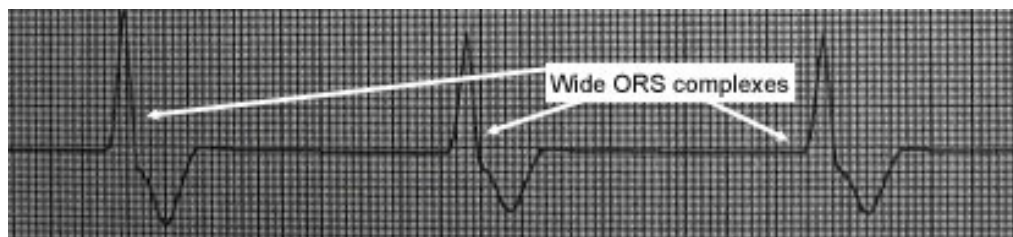

What is the rate? **33-38 bpm**  
Is the rhythm regular or irregular? **Regular**  
Is there a P wave present? **None**  
Is the PR interval fixed or varied? **None**  
Is the QRS wide or narrow? **Wide**

We know that the intrinsic rate for a ventricular paced rhythm (Purkinje fibers) is between 20-40 bpm. From the questions we can see that we have a regular paced rhythm, rating between 33-38 bpm (intrinsic rate for Purkinje fibers), with a wide QRS. From these results we can assume that this is a ventricular paced rhythm.

### **Summary**

Remember, a rhythm rating between 20-40 bpm, with a consistently wide QRS complex and absent P waves = Idioventricular rhythm.

### Accelerated Idioventricular Rhythm

We saw in junctional rhythm how the addition of the word “accelerated” simply refers to the same rhythm at a faster rate. Accelerated idioventricular rhythm is no different. Let’s look at Figure 11 and answer the five questions.

Figure 11. *Accelerated idioventricular rhythm*



What is the rate? **50 bpm**

Is the rhythm regular or irregular? **Regular**

Is there a P wave present? **None**

Is the PR interval fixed or varied? **None**

Is the QRS wide or narrow? **Wide**

So we can tell that this is an idioventricular rhythm, but at what rate do we label it as being accelerated? An idioventricular rhythm will have a rate between 20-40 bpm. If the rate is between 40-60 bpm then we can label this rhythm as an accelerated idioventricular rhythm. Make sense?

How are you doing so far? Ready for a little more? Come on, not too many more to get through before we can test some skills!

### Ventricular Tachycardia (V-tach)

Ventricular tachycardia isn’t supportive of adequate cardiac output or life. It is one of the most serious dysrhythmias. Review Figure 13 and complete the five questions.

Figure 12. Courtesy of: Newberry (2003)

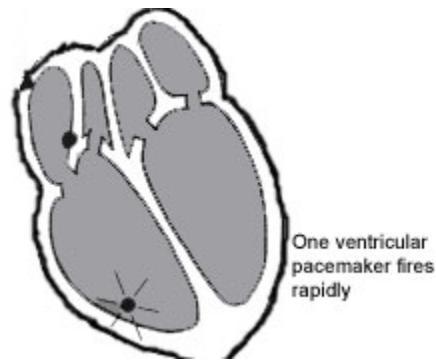

Note how there is one single focus in the ventricles that is generating a rapid rhythmic impulse. This is responsible for the rhythm you see in Figure 13.

Figure 13.

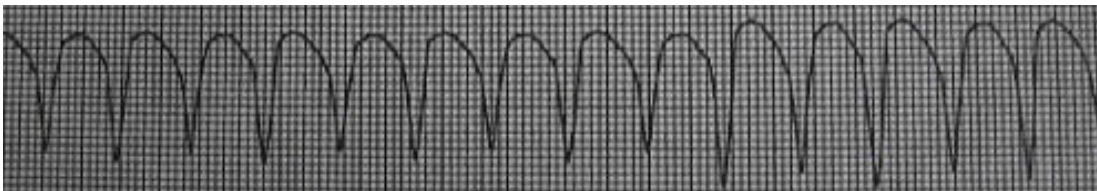

What is the rate? **150-300 bpm**  
Is the rhythm regular or irregular? **Regular**  
Is there a P wave present? **None**  
Is the PR interval fixed or varied? **None**  
Is the QRS wide or narrow? **Wide**

As you can see the ventricles of the heart are working extremely hard. Due to this action the ventricles can never completely fill, resulting in greatly diminished cardiac output. This is a life-threatening situation. Don't panic though when you see this rhythm, look at the patient and see how they tolerate this. Some people may be able to tolerate this rhythm for a very short period, while other patients may be without a pulse, so be sure to assess the patient before you go and show the colleagues how weird this rhythm looks!

### **Summary**

Remember, a rapid rhythm with wide rapid QRS complexes with no P waves = ventricular tachycardia.

### Ventricular Fibrillation (V-fib)

Unlike atrial fibrillation, ventricular fibrillation cannot sustain life. The ventricles are depolarizing without coordination, resulting in total chaos within the ventricles. See Figure 14.

Figure 14. Courtesy of: Newberry (2003)

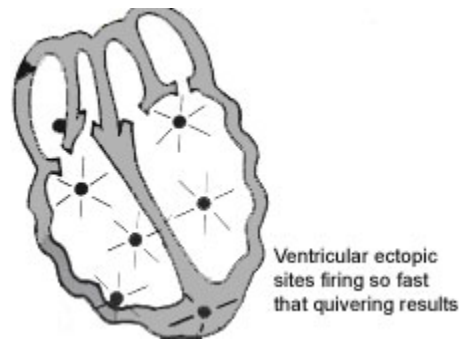

Note the numerous sites that are generating electrical impulses. These electrical impulses cause the ventricles to quiver instead of depolarize uniformly. What's next you say? Well let's answer the five questions.

Figure 15. Ventricular Fibrillation

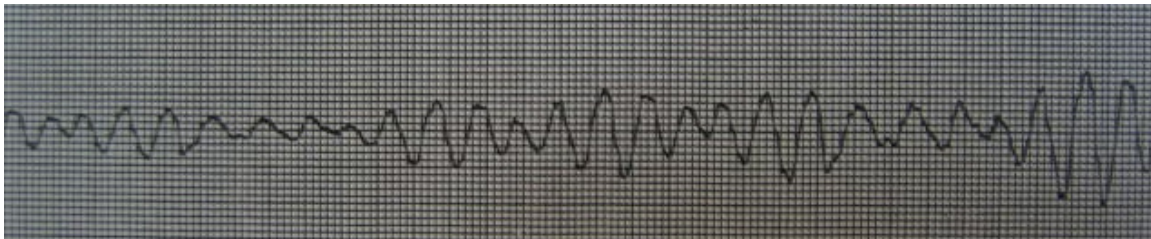

- What is the rate? **Unknown**
- Is the rhythm regular or irregular? **Chaotic**
- Is there a P wave present? **None**
- Is the PR interval fixed or varied? **None**
- Is the QRS wide or narrow? **None**

So from the five questions we get a picture of what is occurring with the ventricles. There is chaos in the ventricles with no clear electrical impulse being conducted. There is no sustainable cardiac output and therefore the patient would not have a pulse. If you identify this rhythm, make sure it is not due to artifact. Look at the patient and check for a pulse; it is not distinguishable. Always treat the patient, not the rhythm.

#### *Artifact*

Is a variance in recording that does not originate from the heart's normal electrical activity. There are two main causes. First, any action by the patient may produce artifact. Therefore you must consider such things as talking, shivering and even pain as possible impediments to the EKG. Electrodes must be placed correctly, with a firm bond to the patient's skin. It may be necessary to remove patient's hair to ensure connection. Second, environmental factors will cause artifact to appear on the EKG tracing. Therefore be aware of automated blood pressure cuffs, monitors and even infusion pumps as possible producers of artifact. Colleague's bumping a bed or performing other tasks will also cause artifact, so always be aware of the patient and the surrounding environment.

## Summary

Remember, a rhythm where you cannot identify any real wave morphology = ventricular fibrillation.

## Asystole

This is the easiest rhythm to identify. “A” meaning without and “systole” meaning ventricular contraction (heart beat). Worded simply this means the patient is without a heartbeat. This patient has no pulse.

Figure 16. Courtesy of: Newberry (2003)

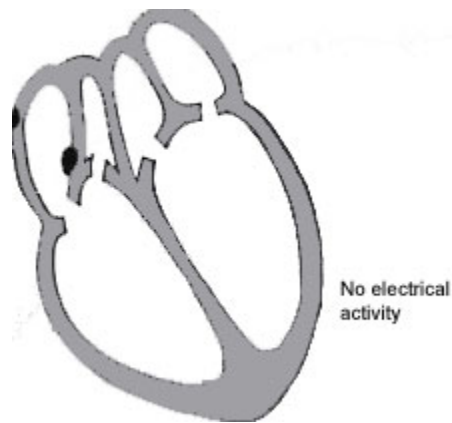

Note how there is no electrical activity being initiated or conducted throughout the heart. All pacemakers fail to initiate any activity. For consistency let's go through the five questions. See Figure 17.

Figure 17. Asystole



What is the rate? **None**

Is the rhythm regular or irregular? **None**

Is there a P wave present? **None**

Is the PR interval fixed or varied? **None**

Is the QRS wide or narrow? **None**

Makes sense doesn't it? With an asystole rhythm there is one important thing to remember. Be sure to check that all the electrodes are secure and that the patient is actually pulse-less. Like V-fib, it is embarrassing calling the “code team” on a patient who is in normal sinus rhythm with an electrode that has fallen off. The code team will never see the humor in it, especially at 4 a.m.

## Pacemaker Rhythms

When a patient's natural pacemaker has trouble initiating and sustaining rhythms consistent with sufficient cardiac function, he or she is implanted with an artificial pacemaker. Put simply, these devices are artificial impulse generators used to substitute for the part of the cardiac cycle that is dysfunctional. There are three types of artificial pacing, each represented differently on a rhythm strip. See Figures 18-20.

In the first example (Figure 18) you can see how there are lines in front of the P wave. These are known as "spikes" and are generated by an artificial electrical impulse. As the position of the spike is before the P wave, we can see that the impulse has depolarized the atria (P wave), then passed through the AV node and conducted normally through the ventricles.

Figure 18. *Atrial pacing*

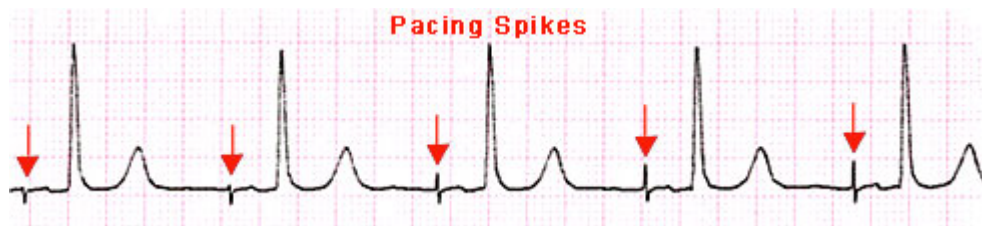

Can you see the spike is before the ventricles in Figure 19? Like the example above, this artificial impulse has depolarized the ventricles. Evidently, this results in the widening of the QRS complex, as the impulse origin is within the ventricles.

Figure 19. *Ventricular pacing*

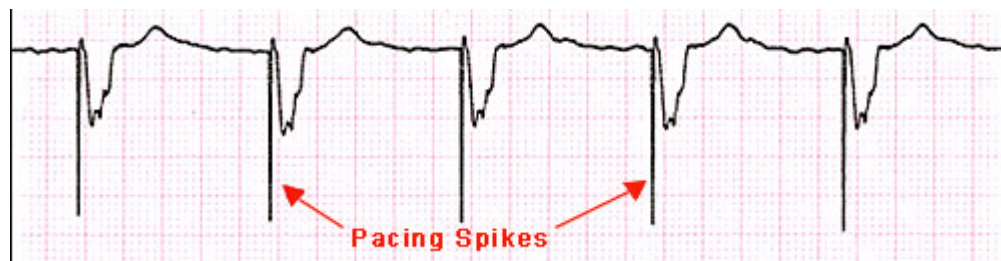

When we put these two artificial pacing systems together, it is known as dual pacing. Simply stated there is an impulse directly connected to stimulate the atrium, while another is connected to stimulate the ventricles. See Figure 20. This dual system will ensure that both the atria and ventricles perform in unison. Note the presence of normal P waves preceded by a wide QRS complex.

Figure 20. *Dual pacing*

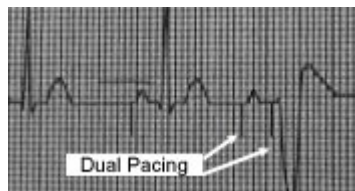

You may see pacing spikes that continue for each heart beat, or it may only be present every now and then. If this is occurring don't worry. The pacemaker may be set to fire all the time or only when the heart's natural pacemaker fails to initiate an impulse. Look at Figure 20. Note how the first three beats utilize atrial pacing, while the other beats are dependant on dual pacing.

There is a lot of information to learn initially, but stay patient. At this time be sure that you are following each new rhythm and the changes that they represent.

Okay, let's move on to the final section.



## Atrioventricular Blocks (AV Blocks)

The thought of discussing heart blocks causes anxiety to most nurses who lack the basic understanding of rhythm strips. Lucky for us, after reading through these sections we have a great understanding of basic rhythm interpretation, so we can expect this section to flow easily. Ready to roll? Let's go.

First some background. What is an AV block?

In normal conduction an impulse is generated in the SA node and conducted through to the AV conduction system (AV node, and Bundle of His). Disease processes can affect the ability of the AV node to conduct impulses to the ventricles. When conduction is impaired, we term these "blocks." There are three types of AV blocks each representing a differing degree of disease and conduction impairment. Let's go through these one by one.

The key to interpreting blocks is to pay attention to the PR interval. Continue on to see.

### First-Degree Heart Block

The first type of AV block is termed first degree AV block. Remember back to the basic electrophysiology section in the first course of this series (Basic EKG Interpretation)? A normal impulse is generated from the SA node and conducted through to the AV node where it "pauses" for a slight period of time before it is conducted through to the ventricles. In a first degree AV block this "pause" is a little longer than expected. See Figure 21. Do you remember what the normal PR interval is?

If you rattled off 0.12-0.20 seconds or 3-5 small boxes, then I am so proud! Well done.

Figure 21. *Courtesy of: Newberry (2002)*

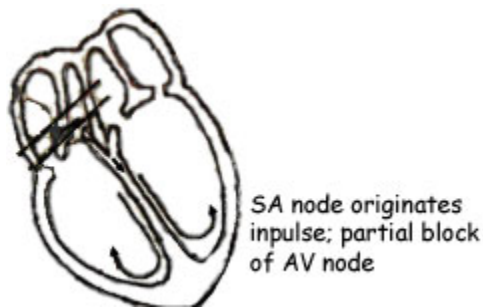

Note how there is a normal impulse stimulus at the SA node. This will, as you know, give us a normal P wave and narrow QRS complex. So how do we tell if it is a first-degree block? Let's look at Figure 22 and work through the five questions.

Figure 22. *First degree block*

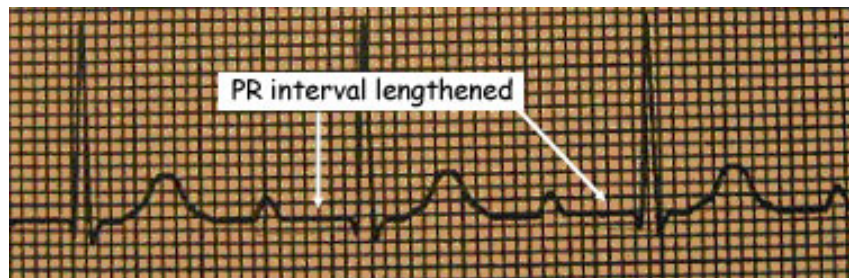

What is the rate? **60-75 bpm**  
Is the rhythm regular or irregular? **Regular**  
Is there a P wave present? **Yes**  
Is the PR interval fixed or varied? **Fixed, lengthened (0.28 seconds or 7 boxes)**  
Is the QRS wide or narrow? **Narrow**

Recap. Here we essentially have normal sinus rhythm with a fixed lengthened PR interval. This represents a longer delay than usual at the site of the AV node. This is a first-degree block. Don't worry if your patient has this block. It can present in normal healthy individuals.

### **Summary**

Remember, a PR interval that is lengthened but constant with normal wave morphology = first-degree block.

Let's progress to the next type of block.

### Second-Degree Heart Block. Type I. (Mobitz I or Wenchebach)

In this rhythm there is a blockage in the conduction at the AV node that is gradually lengthened. This gradual lengthening sets it apart from first-degree block. This blockage gradually lengthens the time an impulse is paused at the AV node until one impulse isn't conducted through to the ventricles, whereby the cycle starts again. This can be seen in Figure 23. Work through the questions.

Figure 23. *Second-degree heart block type I*

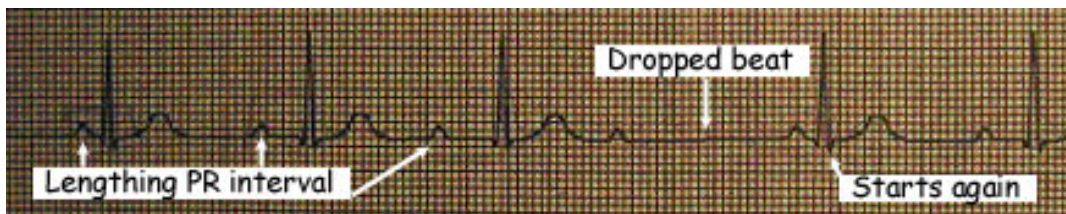

What is the rate? **60-75 bpm**  
Is the rhythm regular or irregular? **Regularly irregular (Predictable)**  
Is there a P wave present? **Yes**  
Is the PR interval fixed or varied? **Varied**  
Is the QRS wide or narrow? **Narrow**

In this rhythm we have a gradually increasing PR interval until we have a situation where a QRS complex doesn't follow a P wave (dropped beat) and then it starts again. This is a predictable cycle that we can say is regularly irregular.

### **Summary**

Remember, a PR interval that is varied with a dropped beat = second-degree type I.

### Second-Degree Heart Block. Type II. (Mobitz II)

Progressing through the blocks, this rhythm is a result of one or more impulses being blocked at the AV node and not conducted through to the ventricles. See Figure 24. Work through the questions.

Figure 24. *Second-degree heart block type II*

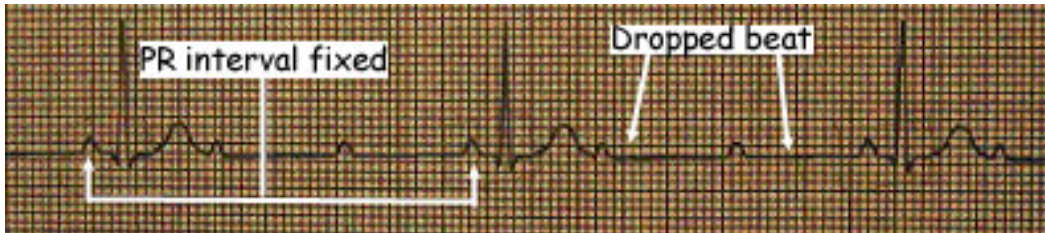

What is the rate? **<43 bpm**  
Is the rhythm regular or irregular? **Regularly irregular**  
Is there a P wave present? **Yes**  
Is the PR interval fixed or varied? **Fixed**  
Is the QRS wide or narrow? **Narrow**

Recap. Here we can see that the atria are generating an impulse (presence of P waves). However, the AV node is only allowing every third beat to conduct through to the ventricles (QRS complex). Remember second-degree type I has a gradually lengthening PR interval then a dropped beat. This rhythm has a fixed PR interval, with consistent blocked beats.

### **Summary**

Remember fixed PR interval with dropped beats = second-degree type II.

### Third-Degree Block (Complete Heart Block)

This is without doubt the most dangerous block a patient can have. So far we have progressed through three different blocks, from a longer pause at the AV node as seen in first-degree block, gradual pause causing a dropped beat in second-degree type I block and constantly dropped beats in second-degree type II. In complete heart block (third-degree block) we have the atria working independently to the ventricles. There is a complete block at the level of the AV node, where impulses are unable to pass through. What do you think this would look like on a rhythm strip?

Figure 25. *Courtesy of: Newberry (2003)*

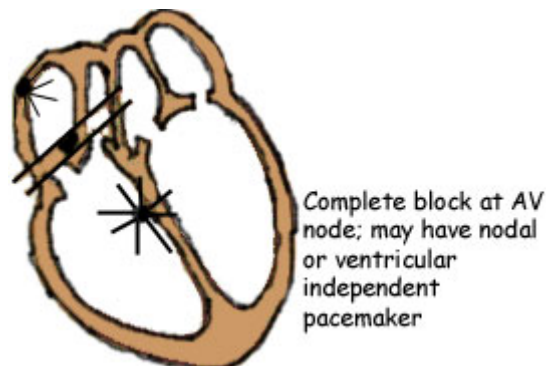

Note how the SA node initiates an impulse that depolarizes the atria. The AV node for some reason is not able to pass this impulse to the ventricles. The ventricle then operates by itself with its own pacemaker. Therefore we have two pacemakers in the heart operating independently.

To conceptualize this, consider the two areas of the heart, the atria and ventricles, as separate entities. The atria are conducting business on its own and the ventricles are conducting business on its own. Each carries on business as usual, depolarizing at their own intrinsic rates. Now put the two on top of each other and you have a heart, where the top is not communicating with the bottom. See Figure 26. Let's work through the questions and gather the clues.

Figure 26. *Third-degree heart block*

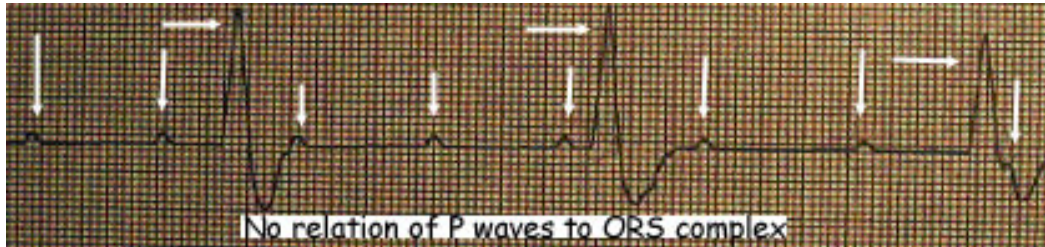

What is the rate? **33-38 bpm**  
 Is the rhythm regular or irregular? **Regular (But P waves are regular and R waves are regular)**  
 Is there a P wave present? **Yes**  
 Is the PR interval fixed or varied? **Varied**  
 Is the QRS wide or narrow? **Wide**

Recap. As you have worked out, this rhythm has P waves and a wide QRS complex. Therefore we know that there is an impulse originating in the atria (P wave) and another in the ventricles (wide QRS complex). Notice how there is no reason to this rhythm. The P waves are constant but in no relation to the QRS complexes, which are also constant. This is termed complete dissociation between the atria and ventricles.

**Summary**

Remember, a rhythm with constant P waves, a varying PR interval, with no association to a widened QRS complex, with regular dropped beats = third-degree block. This block requires immediate intervention, as often the patient will need a permanent pacemaker.

Here is a table to help separate the individual blocks. Be sure to understand this table well, as it will help you identify the blocks much easier.

| Fixed PR interval              | Varied PR interval            |
|--------------------------------|-------------------------------|
| 1 <sup>st</sup> degree block   | 2 <sup>nd</sup> degree type I |
| 2 <sup>nd</sup> degree type II | 3 <sup>rd</sup> degree        |

Note how the table is divided between fixed and varied PR intervals. This is key. If you recall in a fixed PR interval, first-degree won't drop a beat, only second-degree type II does. Therefore, if you have a fixed PR interval and there are dropped beats, it must be second-degree type II. If there is a lengthened but fixed PR interval without a dropped beat then it can only be a first-degree block. If there is a varied PR interval, only one rhythm will have constant dropped beats, third-degree block. If it is a varied PR interval with a single dropped beat it must be second-degree type II. Remembering this table will help you easily identify the block you are trying to identify.

## Wrap up and Rhythm Examples

Well that's it; you have completed part III. Congratulations, take a walk or have a rest, but don't go too far. Be sure to follow on to the practice questions and master the skills of rhythm interpretation. Remember the interval sizes, proper wave morphology and always ask yourself the five questions. These will help you establish the rhythm at which you are looking. If you are uncertain of a rhythm break it down into the questions and revisit the different rhythms in Part III, choosing the most appropriate. Good luck! With continued practice you will be able to identify these rhythms quickly and accurately.

### Example 1

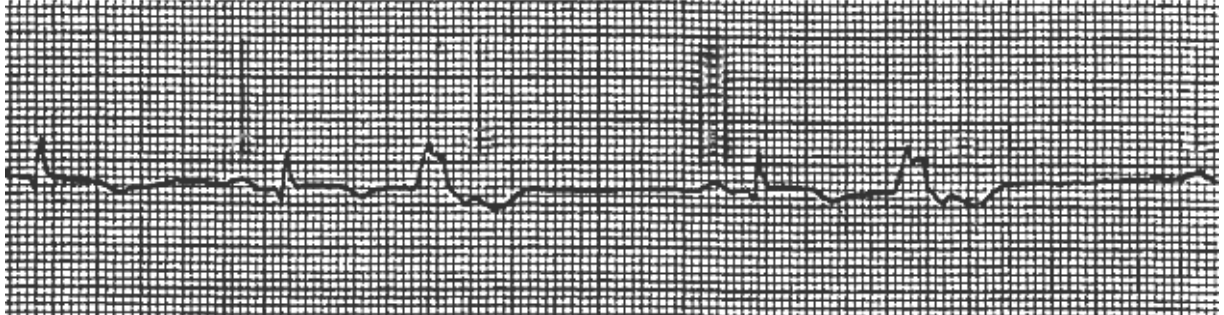

What is the rate?  
Is there a P wave present?  
Is the QRS wide or narrow?  
What is the rhythm?

### Example 2

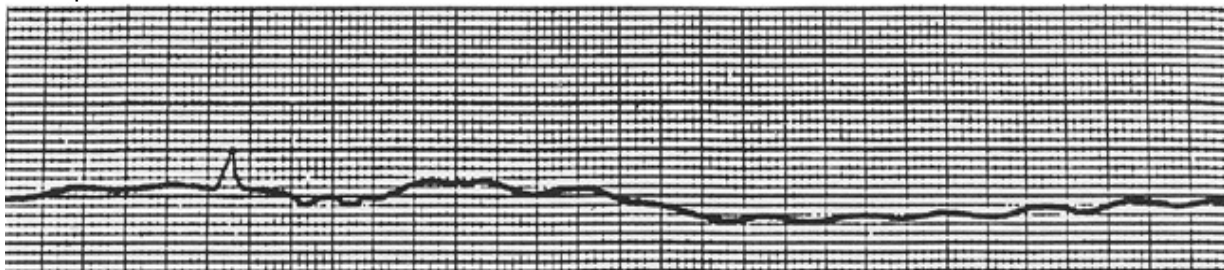

What is the rate?  
Is there a P wave present?  
Is there a QRS present?  
What is the rhythm?

### Example 3



What is the rate?

Is the rhythm regular or irregular?  
Is there a P wave present?  
Is the QRS wide or narrow?  
What is the rhythm?

Example 4



What is the rate?  
Is the rhythm regular or irregular?  
Is there a P wave present?  
Is the QRS wide or narrow?  
What is the rhythm?

Example 5

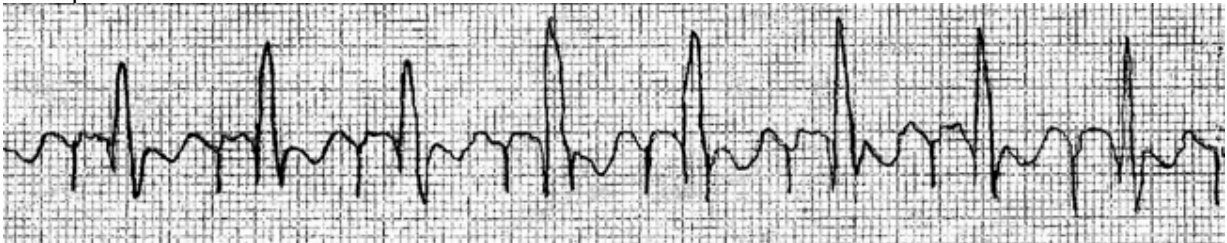

What is the rate?  
Is the rhythm regular or irregular?  
Is there a P wave present?  
Is the PR interval fixed or varied?  
Is the QRS wide or narrow?  
What is the rhythm?

**Turn to page 24 for answers.**

## Answers to Rhythm Examples

### Example 1:

Rate: **Between 60 and 70**  
P present: **Yes**  
QRS narrow or wide: **Narrow**  
Rhythm: **Premature Ventricular Contraction (PVC)**

### Example 2:

Rate: **No rate**  
P present: **No**  
QRS present: **No**  
Rhythm: **Asystole**

### Example 3:

Rate: **300**  
Regular or irregular: **Irregular**  
P present: **No**  
QRS narrow or wide: **Wide**  
Rhythm: **Ventricular Tachycardia**

### Example 4:

Rate: **Too fast to calculate**  
Regular or irregular: **Irregular**  
P present: **No**  
QRS narrow or wide: **Wide**  
Rhythm: **Ventricular fibrillation**

### Example 5:

Rate: **120**  
Regular or irregular: **Regular**  
P present: **Yes**  
PR fixed or varied: **Fixed**  
QRS narrow or wide: **Narrow**  
Rhythm: **Sinus rhythm with pacer spike**

## References

Centers for Disease Control and Prevention. (n.d.). *Preventing heart disease and stroke.*

Retrieved from

<http://www.cdc.gov/nccdphp/publications/factsheets/Prevention/dhdsp.htm>

Emergency Nurses Association, & Newberry, L. (Ed.). (2002). *Sheehy's emergency nursing: Principles and practice* (5<sup>th</sup> ed.). St. Louis, MO: Elsevier Health Sciences Division.



### Electrocardiograms Made Easy! Part III. Interpreting Ventricular Dysrhythmias Course Exam

After studying the downloaded course and completing the course exam, you need to enter your answers online. **Answers cannot be graded from this downloadable version of the course.** To enter your answers online, go to e-leaRN's Web site, [www.elearnonline.net](http://www.elearnonline.net) and click on the Login/My Account button. As a returning student, login using the username and password you created, click on the "Go to Course" link, and proceed to the course exam.

1. Ventricular dysrhythmias originate \_\_\_\_\_ and will result in the QRS complex being \_\_\_\_\_.
  - A. Above the AV node; Wide
  - B. Below the AV node; Narrow
  - C. Below the AV node; Wide
  - D. Above the AV node; narrow
2. A signal originating below the level of the AV node, causing the ventricles to contract out of sync with the underlying cardiac rhythm results in a Premature Ventricular Contraction.
  - A. True
  - B. False
3. A \_\_\_\_\_ is three Premature Contractions in a row.
  - A. Couplet
  - B. Bigeminy
  - C. Trigeminy
  - D. Triplet
4. A rhythm with absent P waves, a wide QRS complex and a rate between 20 – 40 beats per minute is \_\_\_\_\_. Its "pacemaker" is situated within the \_\_\_\_\_.
  - A. Ventricular fibrillation; AV node
  - B. Accelerated idioventricular; Purkinje fibers
  - C. Idioventricular rhythm; Purkinje fibers
  - D. Ventricular bradycardia; SA node
5. Ventricular tachycardia results in a rhythm with an upside down P wave, narrow QRS complex and originates in the SA node. It is rarely life threatening.
  - A. True
  - B. False
6. A chaotic rhythm lacking any coordinated wave morphology is called \_\_\_\_\_. Remember to differentiate this actual rhythm from artifact.
  - A. Ventricular fibrillation
  - B. Atrial flutter
  - C. Idioventricular rhythm
  - D. Ventricular tachycardia

7. Atrial pacing will often result in a “spike” \_\_\_\_\_.
- A. After the P wave
  - B. Before the QRS complex
  - C. Before the T wave
  - D. Before the P wave
8. A rhythm with a fixed and lengthened PR interval without the presence of a dropped beat is a:
- A. Second-degree type I block
  - B. First-degree block
  - C. Second-degree type II block
  - D. Third-degree block
9. Dissociation between the atria and ventricles resulting in both areas operating independently
- A. Second-degree type I block
  - B. First-degree block
  - C. Second-degree type II block
  - D. Third-degree block
10. A \_\_\_\_\_ will have a varied PR interval and drop the occasional beat.
- A. Second-degree type I block
  - B. First-degree block
  - C. Second-degree type II block
  - D. Third-degree block