

Electrocardiograms Made Easy! Part I. Basic EKG Interpretations

NYSNA Continuing Education

The New York State Nurses Association is accredited as a provider of continuing nursing education by the American Nurses Credentialing Center's Commission on Accreditation.

This course has been awarded 1.5 contact hours.

All American Nurses Credentialing Center (ANCC) accredited organizations' contact hours are recognized by all other ANCC accredited organizations. Most states with mandatory continuing education requirements recognize the ANCC accreditation/approval system. Questions about the acceptance of ANCC contact hours to meet mandatory regulations should be directed to the Professional licensing board within that state.

NYSNA has been granted provider status by the Florida State Board of Nursing as a provider of continuing education in nursing (Provider number 50-1437).

How to Take This Course

Please take a look at the steps below; these will help you to progress through the course material, complete the course examination and receive your certificate of completion.

1. REVIEW THE OBJECTIVES

The objectives provide an overview of the entire course and identify what information will be focused on. Objectives are stated in terms of what you, the learner, will know or be able to do upon successful completion of the course. They let you know what you should expect to learn by taking a particular course and can help focus your study.

2. STUDY EACH SECTION IN ORDER

Keep your learning "programmed" by reviewing the materials in order. This will help you understand the sections that follow.

3. COMPLETE THE COURSE EXAM

After studying the course, click on the "Course Exam" option located on the course navigation toolbar. Answer each question by clicking on the button corresponding to the correct answer. All questions must be answered before the test can be graded; there is only one correct answer per question. You may refer back to the course material by minimizing the course exam window.

4. GRADE THE TEST

Next, click on "Submit Test." You will know immediately whether you passed or failed. If you do not successfully complete the exam on the first attempt, you may take the exam again. If you do not pass the exam on your second attempt, you will need to purchase the course again.

5. FILL OUT THE EVALUATION FORM

Upon passing the course exam you will be prompted to complete a course evaluation. You will have access to the certificate of completion **after you complete the evaluation**. At this point, you should print the certificate and keep it for your records.

Introduction

Electrocardiograms Made Easy! is a series of three courses comprised of: Basic EKG Interpretations, Interpreting Abnormal Atrial Rhythms, and Interpreting Ventricular Dysrhythmias.

The aim of Part I. Basic EKG Interpretations (the first course in the series) is to advance the learners' understanding of the electrocardiogram and develop their skills at reading a basic electrocardiogram rhythm strip. In a cardiac emergency being able to identify the precipitating event is half the battle, a battle in which "time is muscle."

As the song by Cruel Sea states, "the heart is a muscle and it pumps blood, like a big old black steam train." If its function were as simplistic as this, then there would be no need to read on. However this is not the case and there have been a lot of advances in the way we think about and assess the functioning of the heart. If you listen to an orthopedic surgeon, the heart's main purpose is to pump antibiotics around the body. Depending on your position in the healthcare environment, your idea of the heart's function may be similar. But for nurses, the heart and its associated problems is one of the most common ailments afflicting those for whom we care.

Cardiovascular disease is composed of heart disease and cerebrovascular accidents (strokes). Respectively, they are the leading and third leading cause of death in the United States. Together they account for the death of 950,000 Americans each year (Centers for Disease Control and Prevention [CDC], n.d.). More broadly, 61 million Americans (almost one in four) suffer from some form of cardiovascular disease (CDC, n.d.). With tightening purse strings, the impact of cardiovascular diseases on healthcare resources is astounding. The Center for Disease Control and Prevention (CDC) estimates that in 2003 the cost of cardiovascular disease to the economy was \$351 billion (CDC, n.d.). So what does this mean to you?

As active participants in health care you will undoubtedly come in contact with the one in four Americans who have cardiovascular disease. This contact may be in any setting: from an emergency department, surgical ward, rehabilitation, or your own family home. So it is important to be familiar with and understand the basics of one of the easiest, most cost-effective, non-invasive tests performed to assess cardiac function: the electrocardiogram (EKG). It is important to be able to interpret electrocardiograms in order for the skilled registered nurse to initiate timely interventions.

This course will discuss the basics of the electrocardiogram, introduce an easy to remember method for rhythm analysis and build confidence in undertaking and interpreting the basic rhythm strip. There is an emphasis on not letting the reader be "bogged down" with technical jargon and instead focus on identifying what is "normal" in an electrocardiogram rhythm.

Content Outline

- Background
- Electrical Physiology
- Recording Electrical Impulses (The technical stuff)
 - The "How To" Perform an EKG
- Understanding Wave Morphology
- The Significance of Wave Recording
- Interpreting a Basic Rhythm Strip
- Summary and Practice Examples

Course Objectives

Upon the completion of this course the learner will be able to:

- Describe the electrical physiology of the heart.
- Identify current electrode placement for performance of a 12 lead electrocardiogram.
- Identify the five characteristics used to determine a cardiac rhythm.
- Recognize the characteristics of normal sinus rhythm.

About the Author

David Pickham, MN, RN, began his nursing education at the University of Newcastle in New South Wales, Australia. He has since worked as a registered nurse focusing on emergency medicine in Australia, Canada, and the United States. He has a master's of nursing in advanced practice and currently is a doctoral candidate at the University of California. His interests lie specifically in the field of electrocardiography (also known as ECG or EKG) which led him to create courses on Electrocardiograms Made Easy!

This course was updated in August 2008 by **Sally Dreslin, MA, RN, CEN**. Ms Dreslin is an Associate Director in the Education, Practice and Research Program of the New York State Nurses Association.

Background

Willem Einthoven, a Dutch physiologist, was responsible for developing the technique of recording the electrical activity of the heart (Bullock, Boyle, & Wang, 2001). Later winning a Nobel Prize for his efforts, the electrocardiogram (EKG) has since become the mainstay in the initial assessment of cardiac function. Importantly the EKG will not measure the heart's mechanical action; instead the EKG records the electrical activity responsible for cardiac function. Understanding the relationship between the mechanical/electrical systems within the heart will help conceptualize the EKG.

Figure 1. "An Early EKG" Courtesy of: Stichting Einthoven/Einthoven Foundation, the Netherlands



Electrical Physiology

Cardiac cells are physiologically unique within the body. These cells have the capability to initiate electrical activity (automaticity), respond to electrical activity (excitability), relay an impulse (conductivity), and react physically to a stimulus (contractility). The importance of these characteristics in cardiac functioning will be evident throughout.

For the heart to perform a beat, a signal must be sent through the heart telling its muscle to work (contract). This “signal” originates in the right atrium in a specialized group of cells termed the SA node (sino-atrial node). The SA node propagates a signal approximately 60-100 times per minute (Newberry, 2003). This signal or impulse moves from the SA node to the atria and AV node (atrio-ventricular node) through “signal highways” in the atria (intra-atrial tracts). During this time atrial contraction occurs. Once at the AV node the signal is delayed or “held-up” for a fraction of time, before it is allowed to progress. This slight delay allows the atria to finish contraction before ventricular involvement.

After a small delay the impulse travels from the AV node to the ventricles through another specialized highway located in the septum of the ventricles. This highway is called the Bundle of His. The Bundle of His branches into the left and right bundle branches, and each delivers the impulse to their respective ventricles. Once in either ventricle these branches continue to form smaller branches (much like a river stream) called Purkinje fibers. These smaller branches (Purkinje) deliver the impulse to the rest of the ventricle muscle whereby contraction occurs. The delivery of an impulse occurs simultaneously down the left and right ventricle. Refer to Figure 2 for a visual illustration.

Figure 2. “Conduction System Pathway” Courtesy of: University of Otago

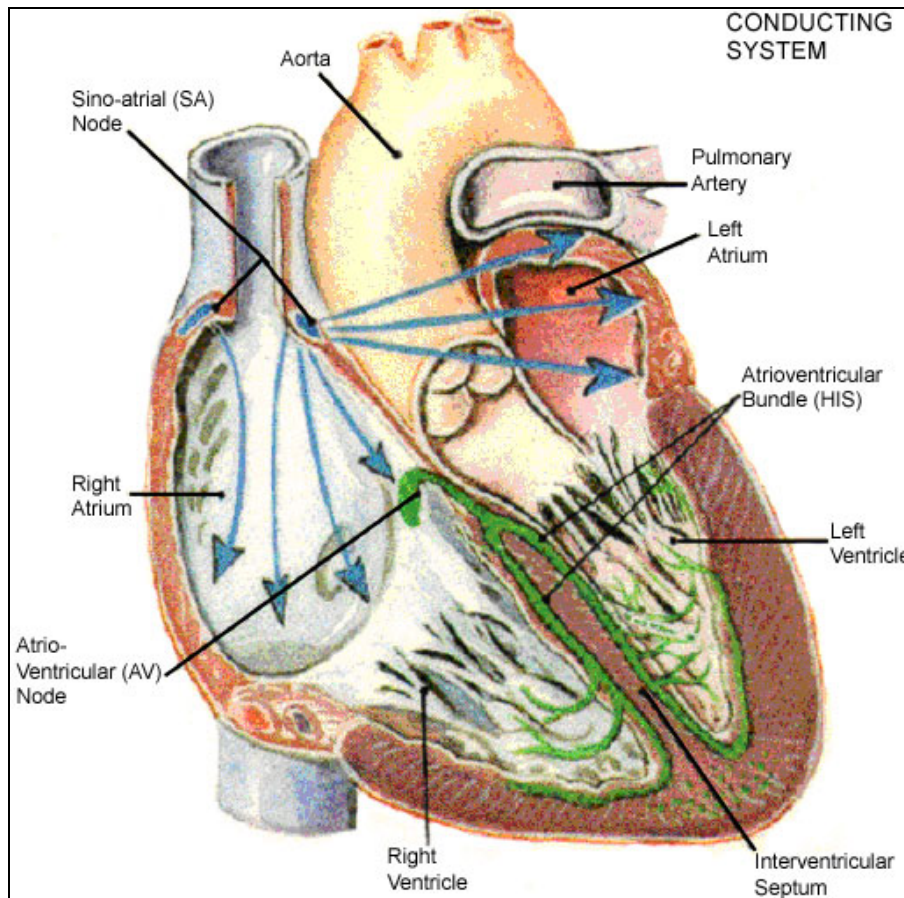

In Summary:

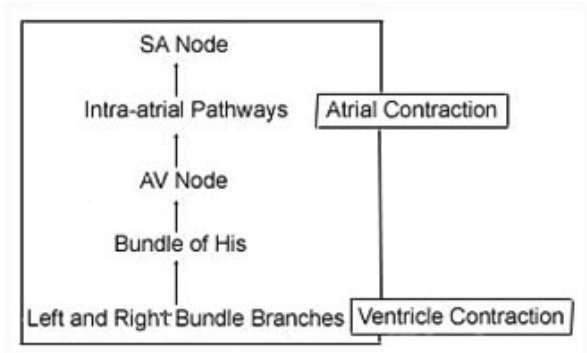

Recording Electrical Impulses (The technical stuff)

In earlier periods an EKG was performed by placing a patient's arms and legs into wired buckets filled with an electrolyte solution (Lilly, 2002) and recording the voltage difference (See Figure 1 "An Early EKG" in the Background section). We have since advanced on this method considerably. Today we perform an EKG by placing ten electrodes in a pre-determined pattern on the patient's skin. These electrodes are then used by a galvanometer (a fancy sounding device used to measure low voltage currents) to record the voltage difference between any two electrodes. With a goal of decreasing the learner's anxiety of EKG performance and interpretation, the exact science behind action potentials and measurement will not be discussed. Knowledge of this is not pertinent to interpreting the basic EKG.

The "How To" Perform an EKG

Don't be misled by the term 12 lead EKG. As stated above, an EKG requires the placement of ten leads (or electrodes). Simply stated, the galvanometer uses the ten leads to make twelve different recordings. Depending on the type of EKG needed, the leads are placed in a specific location. The following is the basic locations for a 12 lead EKG:

- 4 limb leads
 - Right Arm (RA), Left Arm (LA)
 - Right Leg (RL), Left Leg (LL)
- 6 precordial (chest) leads (see Figure 3)
 - V1 - 4th intercostals space, right sternal border
 - V2 - 4th intercostals space, left sternal border
 - V3 - In between V2 and V4 (5th intercostals border)
 - V4 - 5th intercostals space, midclavicular line
 - V5 - 5th intercostals space, anterior axillary line
 - V6 - 5th intercostals space, midaxillary line

Figure 3. "Chest Lead Location" Courtesy of: EMS Solutions (<http://ems-safety.com>)

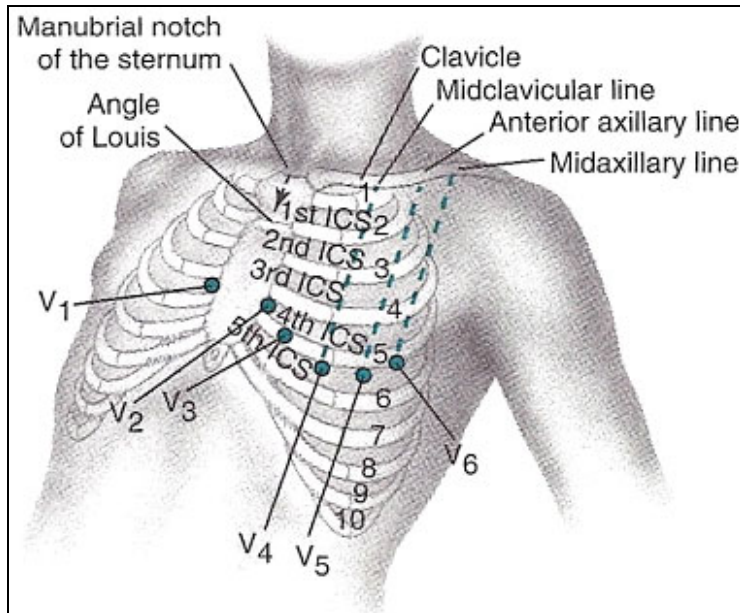

Note: Each lead is recording a snapshot of the electrical activity within the heart at a given time, from its perspective.

Not So Difficult Right? Now, Understanding What Has Happened

By now you have a basic understanding of the electrical system of the heart and the technique for performing an EKG.

Depending on the brand of EKG that your organization uses, your printout page will basically have a lot of differing lines each with a separate heading. Each one of these lines represents a different view of the cardiac function. At this stage we are ONLY interested with the line that says II (lead 2). Often this is printed on the bottom of the page and again on the left hand side.

When we look at wave morphology (Figure 4) we can see three distinctive waves or deflections. Revert back to the electrical physiology skills and we will review these in context. Note the labeling of these three deflections as the P wave, QRS complex, and the T wave. Don't worry about anything else at this stage, it isn't important.

What do these represent? Thinking back, the SA node produces an impulse that travels through intra-atrial pathways to the AV node, causing atrial contraction. This is shown by the P wave (referred to as depolarization of the atria). If you notice it moves from a straight line (baseline) to a small wave and then back to baseline. The return to baseline represents the small delay experienced at the AV node. After the impulse is received from the atria, the atria can relax and regroup. During this time the impulse travels to the ventricles via the Bundle of His and the Purkinje fibers. This action contracts the strong ventricles and is represented by the larger QRS complex (group of waves deemed Q, R, and S), representing the time the depolarization takes to spread through the ventricles (don't worry about the individual letters at this stage, just keep in mind QRS = ventricular depolarization). After a small delay, regrouping of the ventricles (repolarization) is represented by the T wave. The wave is much bigger when the ventricles contract, as the ventricles are markedly larger than the atria.

Figure 4. "Basic EKG Morphology" Courtesy of: University of Utah School of Medicine

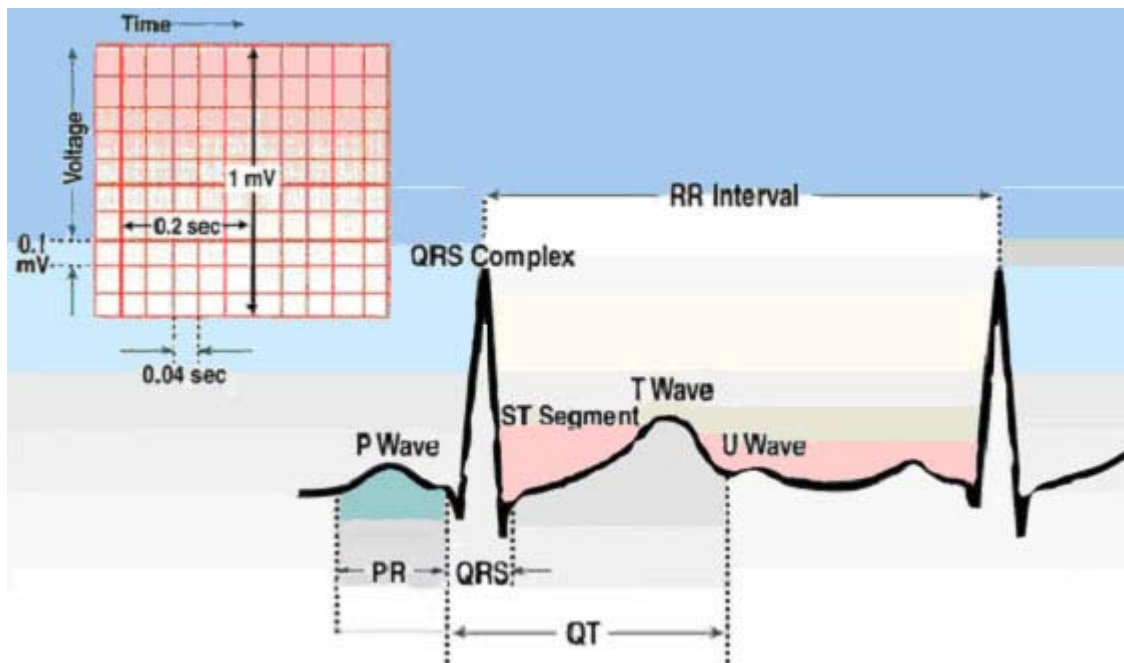

In the normal cardiac cycle the P wave must be followed closely by the QRS complex and likewise each QRS complex must be preceded by a P wave. As we now know, this will mean that the stimulus for a heartbeat has originated in the atria (P wave) and then excited the ventricles (QRS wave). Think of the mechanics of a normal heartbeat: the atria will contract and then the ventricles.

Question: I now know what these waves and intervals represent, but why do the waves look different in each lead?

Don't worry, it all means the same thing but is represented differently depending on each leads' viewpoint. Imagine if you will that you and two friends are watching a float drive by and you are all in different viewing positions. Each person will have a unique view, one viewing side-on, one viewing head-on, and another viewing the other side. No two views look the same despite seeing the same event. This is what is occurring on an EKG. Look at Figure 5 which represents the precordial (chest) leads. See how the waveform is recorded in the differing views. Don't get caught up on this! Accept that each lead has a different view of the same event and move on.

Figure 5. "Precordial lead waveforms" Used with permission from eMedicine.com, Inc., 2007

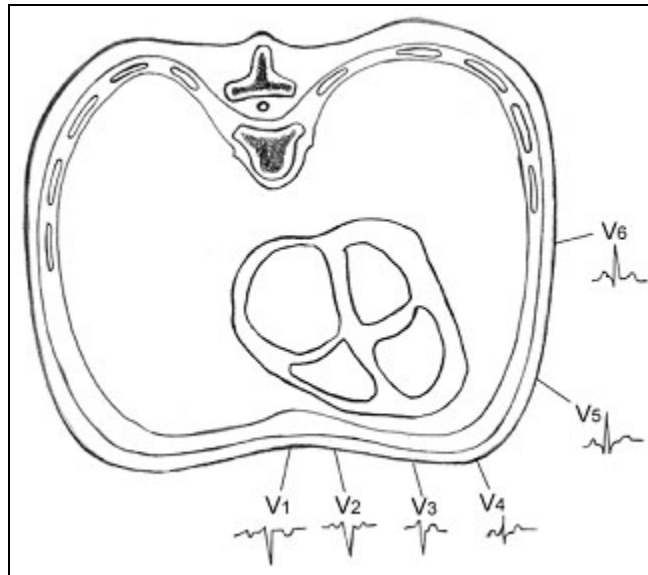

Do you have a thirst for knowledge?

In the resting state the myocardial cell surface has a positive charge compared to the negative charge inside the cell, hence the EKG reading is baseline as both equal and opposite charges cancel each other out. When initially stimulated, the area outside the cell will shift to negative and shift inside to positive. This shift causes an electrical force (depolarization wave) that can be recorded as it travels throughout conducting cells of the heart, changing the surface charge and contracting. The different leads record this wave dissimilarly depending on their location and electrode charge.

The Significance of Wave Recording

We have performed an EKG and recorded the electrical characteristics of the heartbeat. Is there anything else we can learn from this wave morphology? YES. But first we need to understand why we use the paper we use.

EKG paper is special, as its use allows us to calculate the time in various sequences of the cardiac cycle. We know (as it is recorded on the top of the paper) that EKG paper advances 25mm/second (that's five large boxes each second). Deducting from that, one large box (comprised of five smaller boxes) is equal to one fifth of a second or 0.20 seconds. **STAY WITH ME ON THIS.** There are five smaller boxes in one big box, therefore equaling one fifth of 0.20 seconds, or 0.04 seconds. See Figure 6.

Figure 6. "Grid sizing"

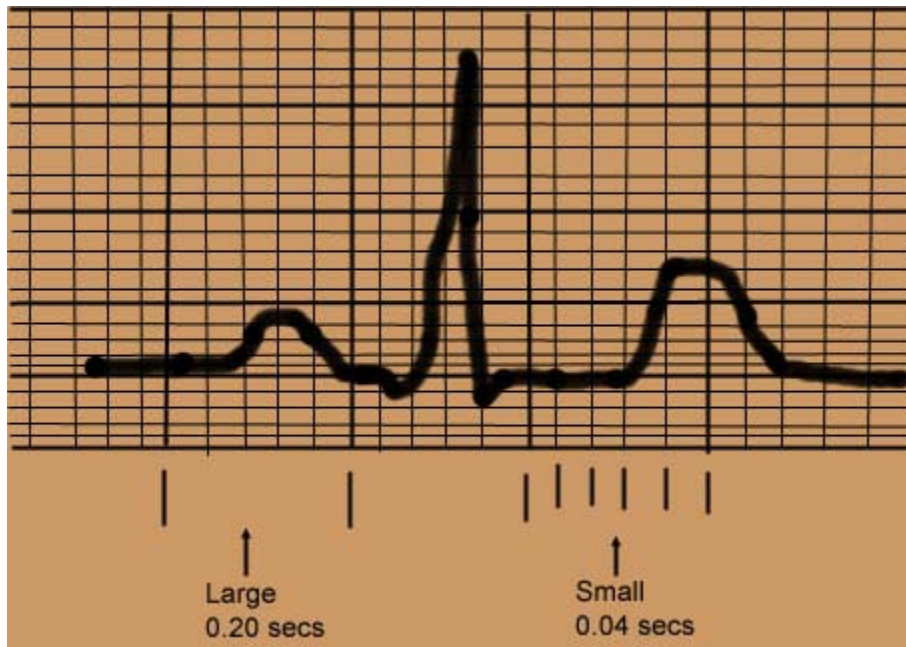

RECAP: Large box = 0.20 seconds. Small box = 0.04 seconds.

Who cares? We do, read on!!

If you look again at Figure 4, you will notice there are brackets between the wave deflections. These brackets are intervals that can be timed and compared to normal cardiac functioning. Labeled, these brackets are the PR interval, QRS interval, and the QT interval. Each interval represents a mechanical function and has a set time for what is considered "normal functioning," beyond these times functioning may be considered abnormal. At this stage in the EKG learning, just be able to understand what is considered normal (you will need to learn these distances). See Figure 7.

- PR interval (Onset of P wave to onset of QRS).
 - Time between onset of atrial depolarization and ventricular depolarization.
 - 0.12-0.20 seconds (3-5 small boxes).
- QRS interval (Beginning to end of the QRS).
 - Duration of ventricular depolarization.
 - Less than 0.12 seconds (3 small boxes).
- QT interval (Beginning of QRS to end of T wave).
 - Beginning of ventricular depolarization to end of ventricular repolarization.
 - Generally no more than 0.40 seconds (10 small boxes).

Figure 7. "Intervals relative to pathway"
Courtesy of: Stichting Einthoven/Einthoven Foundation, the Netherlands

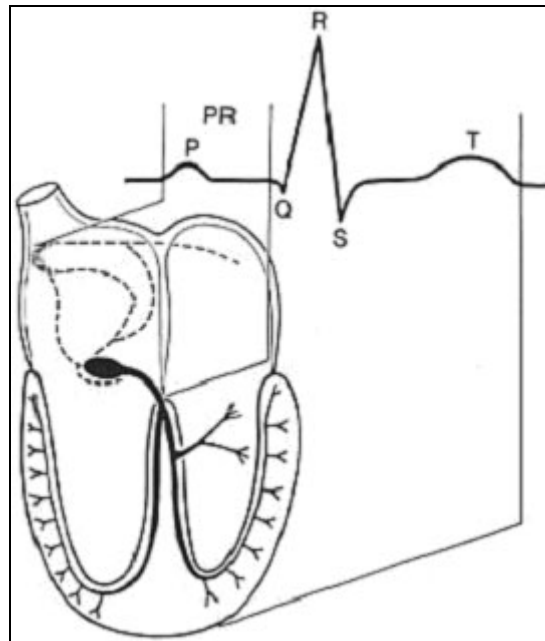

Interpreting a Basic Rhythm Strip

So far we have covered the history behind the EKG, basic electrophysiology, lead placement, and the significance of EKG paper, waveform and intervals as well as their association to the mechanical aspects of cardiac function. Now it is time to move on to determining the basics of EKG reading.

It is easy to cheat while reading EKG's. We are all aware that the computer gives us a nice read-out of the characteristics of the EKG. Up in the top left corner it will spell out everything it can about the EKG. So why do we need to bother to read it?

Like all computers, the EKG is dumb! That's right I said it. It has been known to be wrong. You see an EKG is just one element of a larger clinical picture. Therefore an EKG needs to be interpreted in context with the patient's condition. Don't be lazy and depend on the EKG for information about the patient's cardiac function. There are five simple characteristics we need to identify to successfully read a rhythm strip. Let's go through them one by one.

1. Rate

The first step in reading an EKG is to determine the rate. Like all things in life there is more than one method. Remember back to the wave morphology where the QRS represents ventricular depolarization. This is the period when blood is ejected out of the ventricles into the pulmonary and systemic systems. Calculating the number of times this ejection occurs per minute is the heart rate.

The first method involves counting these heartbeats off the EKG paper. To achieve this, count and mark six seconds on the paper (five large boxes = 1 second, therefore 6 seconds = 30 large boxes). Now count the number of QRS complexes in six seconds and multiply by ten (6 seconds x 10 = 1 minute). See Figure 8.

Figure 8.



Done! You can now correctly determine the rate from an EKG. Congratulations. Do you want to know a more efficient way?

The second method is much quicker. Look at the paper and try to align the R point of the QRS, with a darker line. Now count off each large box with fixed numbers, until you reach the next QRS complex. These numbers are (hint: memorizes these) 300 for the 1st box, 2nd 150, 3rd 100, 4th 75, 5th 60, 6th 50, 7th 43, and so on. This will give you an approximate heart rate. If there are four boxes between the two R waves (QRS complexes) this means the heart rate is 75 beats/minute. Look at Figure 9 and see if you can figure the rate.

Figure 9.

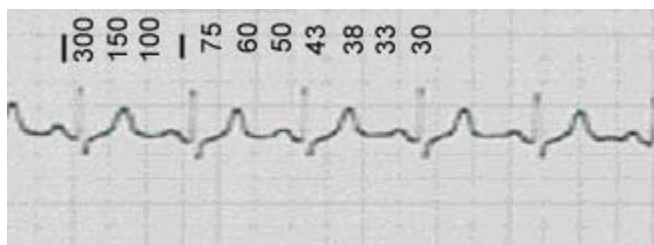

That's right around 100 beats/minute (remember it's an approximate).

2. Rhythm

Now that we can figure out the rate, what we want to check next is whether the heartbeats are regular or irregular. This is important as it can help us identify certain dysrhythmias later on. To assess whether the heart is beating regularly or irregularly we need to "map out" the R and P waves. There are two ways that this can be done. One way is to count the number of boxes between one R wave and the next. Then compare this distance to the next and adjacent R waves. Once the consistency of the R wave is established, map out the P waves. Are the distances between R waves equal? What about the P waves?

WANT THE EASY WAY OUT?

Grab a pen and paper. Place this on top of the EKG readout leaving exposed the R waves. Now make a line corresponding with an R wave, repeat these 3 times. See Figure 10a.

Figure 10a.

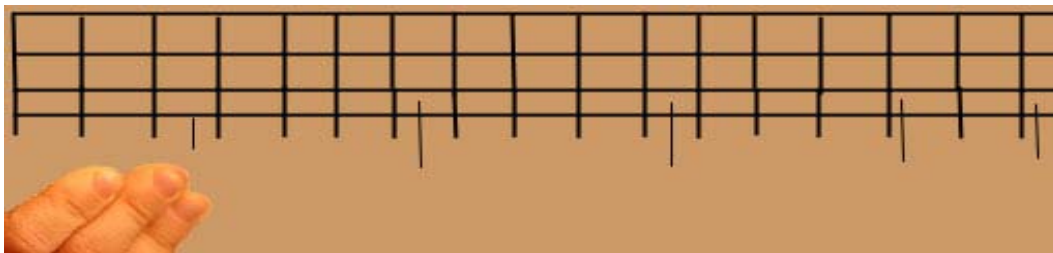

Now move the paper along the rhythm strip comparing the R distances. See Figure 10b.

Figure 10 b.

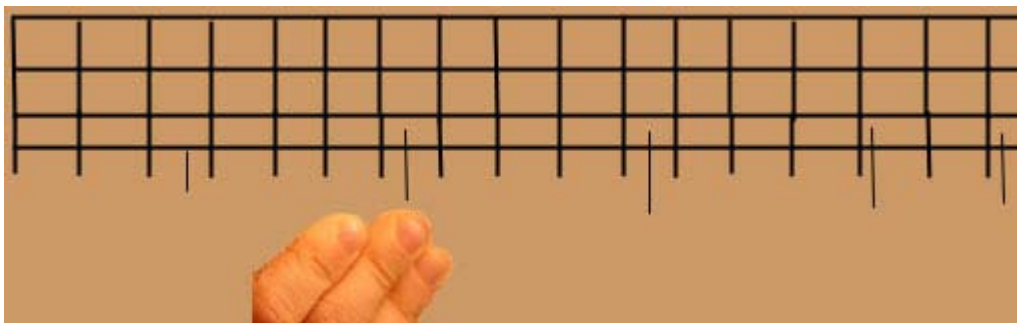

Do the same for the P wave. See Figures 10c and 10d.

Figure 10c.

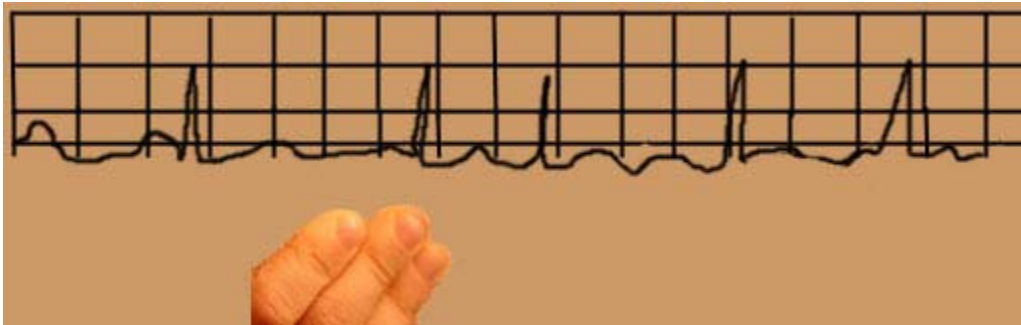
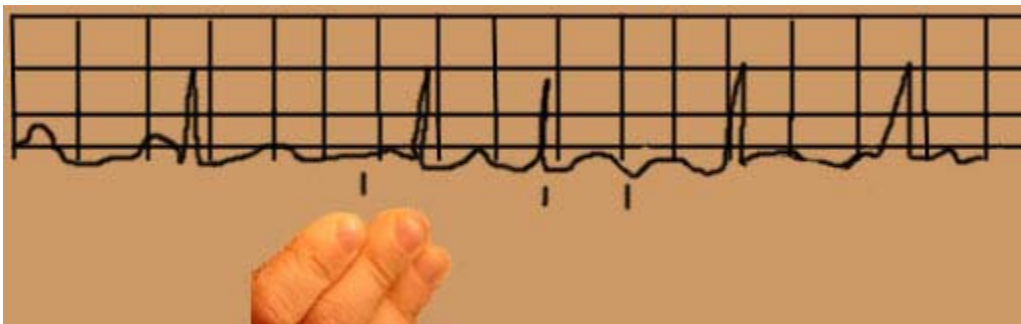

Figure 10d.



See how the distances between the R waves and the distances between the P waves map out with each other. We can now call this rhythm “regular.” At this stage of the game we are only concerned with the rhythm’s rate and whether it is regular or irregular. What is the rhythm rate in Figure 10d? Go back if you need to.

If you answered 75 you are correct, well done. Now we know that the rhythm is regular with a rate of 75 beats per minute. Too easy!

3. & 4. Now Let’s Examine the P Wave

At this stage it is important to identify the presence of a P wave. If it is present we then check if the PR interval is within normal limits (look at Figure 11 for a guide). Can you identify the distance of the PR interval in Figure 12 in the following section?

Figure 11.

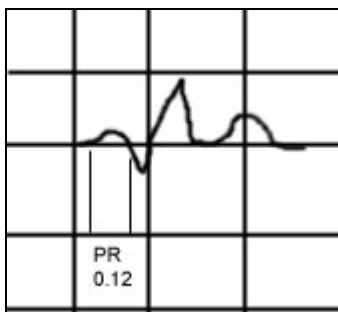

If you said around four small boxes, then once again you are right. Now importantly, compare the PR interval in each beat. Use the mapping technique to determine the rhythm regularity. Is this distance that we have identified the same in each beat? If so, we state that the PR interval is *fixed*. If it wasn’t we say that the PR interval is *varied*.

5. The QRS

Now that you have the rate, we know it is regular and you have the presence of a P wave with a fixed PR interval. It is time to see if the QRS is within normal limits. Do you remember the normal limits? Below is a summary. (You need to remember these!)

Characteristic	Normal limits
PR interval	0.12-0.20 seconds (3-5 small boxes)
QRS complex	0.04-0.12 seconds (1-3 small boxes)
QT interval	Less than 0.40 seconds (10 small boxes)

When considering the QRS complex we know that it should be three small boxes or less, from beginning to end (use Figure 13 as a guide). Look at Figure 12 below and see if you can count it.

Figure 12.

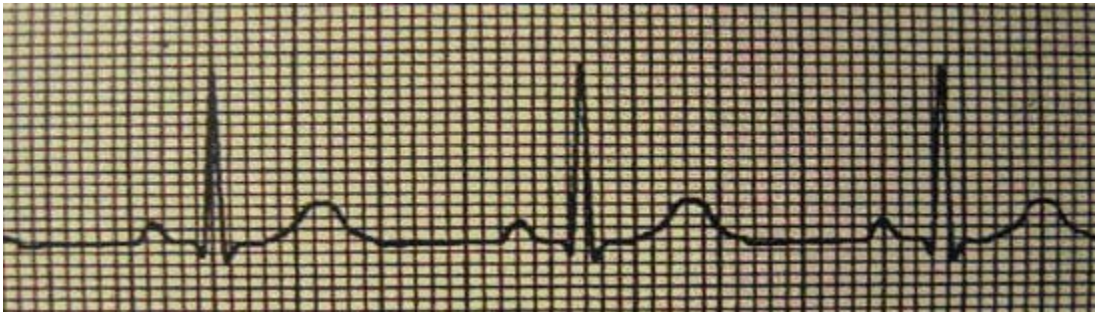

Figure 13.



If the QRS complex measures three boxes (0.12 seconds) or less, we term this *narrow*. If it is greater than three boxes we label this *wide*. The significance of this will be evident later on, for now just be able to identify whether the QRS is narrow or wide. Is the QRS in Figure 12 narrow or wide?

If you said narrow then you're doing well, remember EKG's take practice and you'll get it, but for now just keep up.

Sum it All Up Maestro!

Every time you are given a rhythm to interpret, go through these important five questions. These will help identify the rhythm.

By now you can confidently establish these five steps by yourself.

1. What is the determined rate?
2. Is the rhythm regular or irregular?
3. Is the P wave present?
4. Is the PR interval fixed or varied?
5. Is the QRS wide or narrow?

If you can look at a rhythm and answer these questions you will identify whether the EKG is normal or abnormal, that is the battle. If you are confident about what a normal EKG looks like, then you will easily and quickly recognize an abnormal EKG.

Remember, if the EKG consists of a regular rhythm rate between 60 and 100 (sinus) and you can identify upright P waves that have a fixed PR interval, followed closely by a narrow QRS complex, then you are looking at an EKG that is consistent with normal cardiac function. You have successfully identified the first rhythm, *Normal Sinus Rhythm*. If, however, any of these differed from normal wave morphology then you have identified a dysrhythmia. For interpretation of dysrhythmias please refer to these two additional courses, **Electrocardiograms Made Easy! Part II. Interpreting Abnormal Atrial Rhythms** and **Electrocardiograms Made Easy! Part III Interpreting Ventricular Dysrhythmias**. Before then however, work through these five examples.

Example 1.

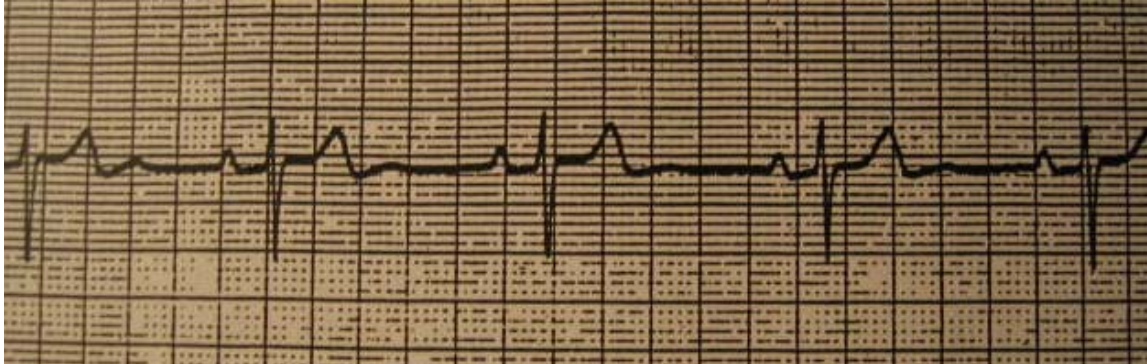

Rate: _____ Regular or Irregular: _____ P present: Y or N

PR Fixed or varied _____ QRS Narrow or wide: _____

What is the rhythm? _____

Example 2.

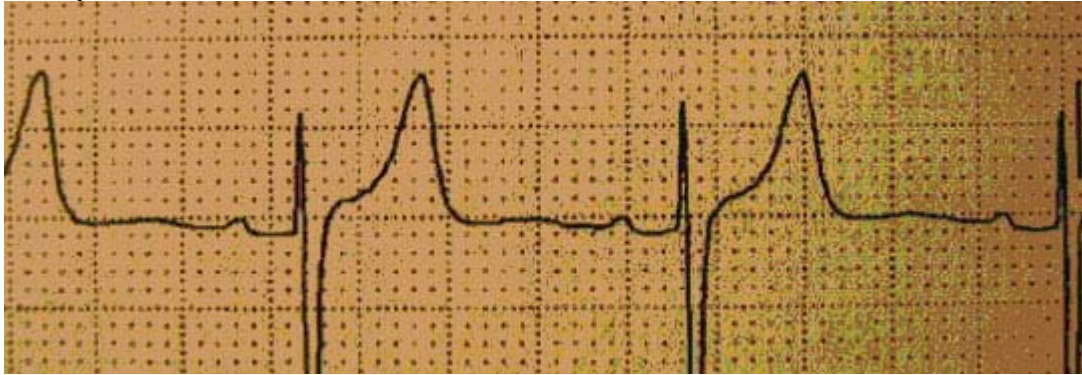

Rate: _____ Regular or Irregular: _____ P present: Y or N

PR Fixed or varied _____ QRS Narrow or wide: _____

What is the rhythm? _____

Example 3.



Rate: _____ Regular or Irregular: _____ P present: Y or N

PR Fixed or varied _____ QRS Narrow or wide: _____

What is the rhythm? _____

Example 4.

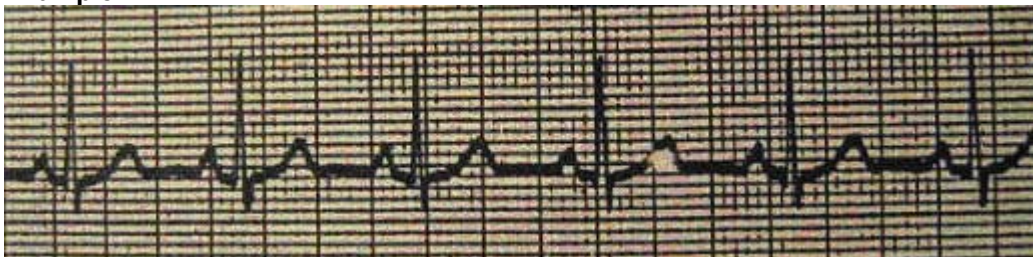

Rate: _____ Regular or Irregular: _____ P present: Y or N

PR Fixed or varied _____ QRS Narrow or wide: _____

What is the rhythm? _____

Example 5.

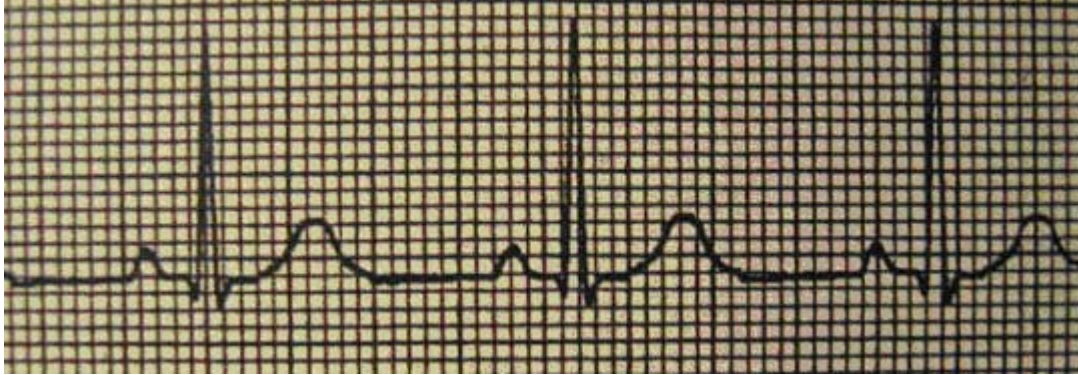

Rate: _____ Regular or Irregular: _____ P present: Y or N

PR Fixed or varied _____ QRS Narrow or wide: _____

What is the rhythm? _____

Please turn to page 21 for the answers to these practice examples.

Hopefully you were able to answer the five questions, and correctly identified these strips as normal sinus rhythm. Now that you can identify a normal EKG, you're ready to take the next course in this series: **Electrocardiograms Made Easy! Part II. Interpreting Abnormal Atrial Rhythms**. Here you will be introduced to abnormal EKG's, where you will learn how to identify and interpret many common dysrhythmias.

Answers to Practice Examples

Example 1:

Rate: **52**
Regular or irregular: **Regular**
P present: **Yes**
PR fixed or varied: **Fixed**
QRS narrow or wide: **Narrow**
Rhythm: **Normal sinus rhythm (NSR)**

Example 2:

Rate: **75**
Regular or irregular: **Regular**
P present: **Yes**
PR fixed or varied: **Varied**
QRS narrow or wide: **Narrow**
Rhythm: **Normal sinus rhythm (NSR)**

Example 3:

Rate: **64**
Regular or irregular: **Regular**
P present: **Yes**
PR fixed or varied: **Fixed**
QRS narrow or wide: **Narrow**
Rhythm: **Normal sinus rhythm (NSR)**

Example 4:

Rate: **90**
Regular or irregular: **Regular**
P present: **Yes**
PR fixed or varied: **Fixed**
QRS narrow or wide: **Narrow**
Rhythm: **Normal sinus rhythm (NSR)**

Example 5:

Rate: **64**
Regular or irregular: **Regular**
P present: **Yes**
PR fixed or varied: **Fixed**
QRS narrow or wide: **Narrow**
Rhythm: **Normal sinus rhythm (NSR)**

References

- 12 Lead EKG. (2007). Retrieved from <http://www.ems-safety.com/12-lead-ekg.htm>
- Bullock, J., Boyle, J., & Wang, M. B. (2001). *Physiology* (4th ed.). Philadelphia, PA: Lippincott Williams & Wilkins.
- Centers for Disease Control and Prevention. (n.d.). *Preventing heart disease and stroke*. Retrieved from <http://www.cdc.gov/nccdphp/publications/factsheets/Prevention/dhdsp.htm>
- Electrocardiogram (ECG)*. (n.d.). Retrieved from http://www.emedicinehealth.com/electrocardiogram_ecg/article_em.htm
- Emergency Nurses Association, & Newberry, L. (Ed.). (2002). *Sheehy's emergency nursing: Principles and practice* (5th ed.). St. Louis, MO: Elsevier Health Sciences Division.
- Lilly, L. S. (Ed.). (2003). *Pathophysiology of heart disease. A collaboration project of medical students and faculty* (3rd ed.). Philadelphia, PA: Lippincott Williams & Wilkins.
- The Einthoven Foundation. (n.d.). *The Einthoven Foundation Cardiology Information Portal*. Retrieved from http://www.einthoven.nl/Einthoven-algemeen/einthoven_historical_pictures.html
- The Hebrew University of Jerusalem, Institute of Chemistry. (2003). *Willem Einthoven*. Retrieved from <http://chem.ch.huji.ac.il/~eugeniik/history/einthoven.html>
- University of Otago. (n.d.). *Heart disease*. Retrieved from <http://highschoolbiology.otago.ac.nz/heart.html>
- Yanowitz, F.G. (n.d.). *A method of ECG interpretation*. Retrieved from http://library.med.utah.edu/kw/ecg/ecg_outline/Lesson2/index.html

Electrocardiograms Made Easy! Part I. Basic EKG Interpretations Course Exam

After studying the downloaded course and completing the course exam, you need to enter your answers online. **Answers cannot be graded from this downloadable version of the course.** To enter your answers online, go to e-learn's Web site, www.elearnonline.net and click on the Login/My Account button. As a returning student, login using the username and password you created, click on the "Go to Course" link, and proceed to the course exam.

1. The order in which a signal is transported through the heart is:
 - A. SA node – AV node – Intra-atrial pathways – Bundle of His – Left/Right bundle branches – Purkinje Fibers
 - B. AV node – Intra-atrial pathways – SA node – Left/Right bundle branches – Bundle of His - Purkinje Fibers
 - C. SA node – Intra-atrial pathways – AV node – Bundle of His – Left/Right bundle branches – Purkinje Fibers
 - D. Purkinje Fibers – SA node – AV node- Intra-atrial pathways - Left/Right bundle braches – Bundle of His

2. The movement of an impulse from the SA node to the AV node causing atrial contraction (atrial depolarization) is represented by a _____ on an electrocardiogram.
 - A. QRS complex
 - B. T wave
 - C. PV complex
 - D. P wave

3. The movement of an impulse from the AV node through to the Purkinje Fibers causing the ventricles to contract (ventricular depolarization) is represented by a _____ on the electrocardiogram.
 - A. T wave
 - B. QRS complex
 - C. P wave
 - D. QPT complex

4. The T wave represents:
 - A. Atrial depolarization
 - B. SA node firing
 - C. Ventricular repolarization
 - D. Time between the onset of atrial contraction and ventricular contraction

5. The expected length of a normal QRS interval is
 - A. 0.12 seconds (3 small boxes)
 - B. 0.40 seconds (10 small boxes)
 - C. 0.12 – 0.40 seconds (3-10 small boxes)
 - D. 0.04 seconds (1 small box)

6. The intrinsic rate of firing for the SA node is
- A. 100 – 140 beats per minute
 - B. 80 – 120 beats per minute
 - C. 60 – 100 beats per minute
 - D. 40 – 60 beats per minute
7. One method in checking if a rhythm is regular is to make a mark on three consecutive R waves and compare (“map out”) the RR intervals.
- A. True
 - B. False
8. One method in calculating the heart rate on an electrocardiogram is to:
- A. Count the number of R waves in 5 small boxes
 - B. Count the number of large boxes between R waves and divide by 60
 - C. Count the number of P waves and add 5
 - D. Count and mark 6 seconds (30 boxes) on your EKG paper and count the number of QRS complexes
9. In a normal electrocardiogram, the P wave followed by a QRS complex represents:
- A. Ventricular contraction followed by atrial contraction
 - B. Atrial relaxation followed by atrial contraction
 - C. Nothing. A P wave will not be followed by a QRS complex
 - D. Atrial contraction followed by ventricular contraction
10. In interpreting an EKG rhythm you first must determine these 5 things: 1) the rate 2) if the rate is regular/irregular 3) if a P wave present 4) if the PR interval is fixed/varied 5) if the QRS wide or narrow.
- A. True
 - B. False